

DIRECTIONAL VALVES

PE12-S67K Proportional, Pilot Operated

U.S. Patent
6,554,014

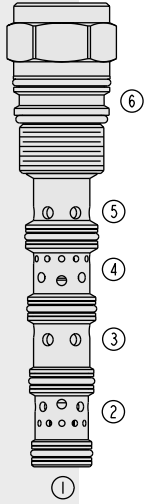

DESCRIPTION

A screw-in, cartridge-style, proportional, spring-centered, pilot-operated spool-type hydraulic directional valve.

OPERATION

When the PE12-S67K is in the neutral position, port ③ is blocked while ②, ④ and ⑤ are connected to each other. When the remote pilot signal at ① exceeds the force of the bias spring, the spool shifts proportionally to the applied pilot pressure to allow flow from ③ to ④ through a load such as a hydraulic cylinder or motor, and from ② to ⑤ and to tank. On remote pilot signal at ⑥, the valve's spool shifts proportionally to the applied pressure in the opposite direction, reversing the flow direction.

The valve's spool is non-symmetrical, providing meter-in control.

FEATURES

- Hardened parts for long life.
- Excellent metering characteristics.
- Good linearity.

RATINGS

Maximum Operating Pressure:

- Ports ③ and ⑤: 345 bar (5000 psi), polyurethane seals are recommended.
- Ports ② and ④: 240 bar (3500 psi)
- Ports ① and ⑥: 27.6 bar (400 psi)

Flow: See Performance Chart

Internal Leakage: 50 ml/minute (3 cu. in./minute) at 207 bar (3000 psi)

Temperature: -40 to 120°C with standard Buna N seals

Filtration: See page 9.010.1

Fluids: Mineral-based or synthetics with lubricating properties at viscosities of 7.4 to 420 cSt (50 to 2000 sus)

Installation: No restrictions; See page 9.020.1

Cavity: VC12-S6; See page 9.112.1

Cavity Tool: CT12-S6; See page 8.600.1

Seal Kit: SK12-6X-BMMMM; See page 8.650.1

SYMBOLS

USASI:

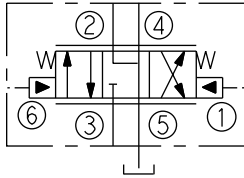

ISO:

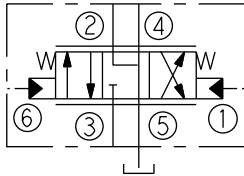

PERFORMANCE (Cartridge Only)

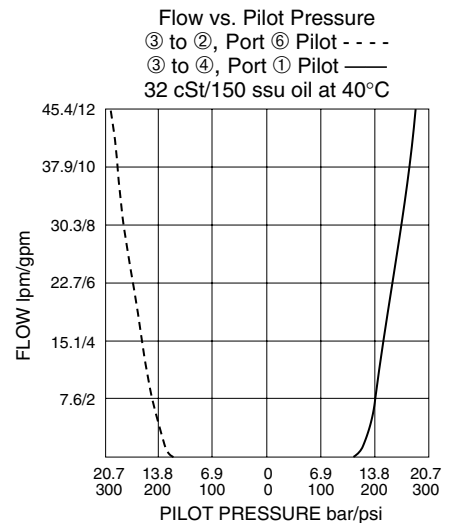
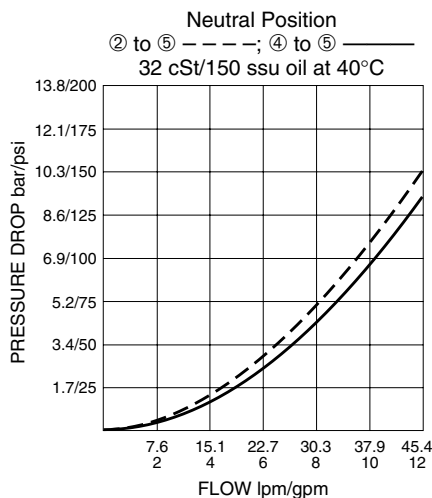
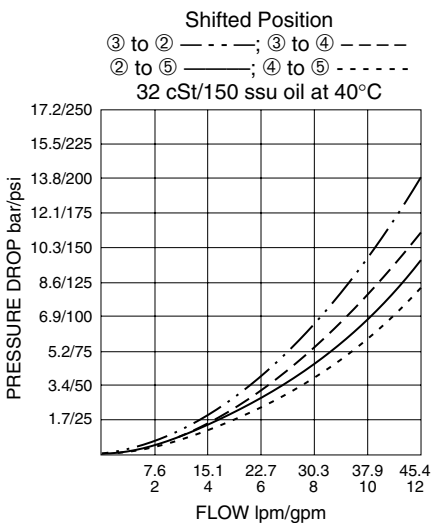

PE12-S67K

DIMENSIONS

U.S. Patent 6,554,014

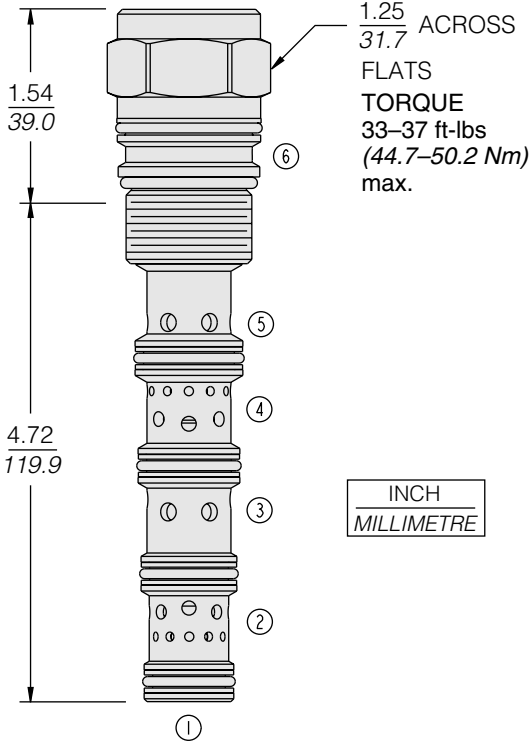

MATERIALS

Cartridge: Weight: 0.45 kg. (0.98 lbs.);
Steel with hardened work surfaces.
Zinc-plated exposed surfaces.
Buna N O-rings and polyester
elastomer back-ups standard.

Ported Body: Test housing available;
see page 8.012.1.

TO ORDER

PE12-S67K - -

Porting
Cartridge Only **0**

Seals
N Buna N (Std.)
P Polyurethane (for pressures over 240 bar/3500 psi)
V Fluorocarbon